





GRANDIO[®]

G R E E N H O U S E S

WOOD ANCHORING KIT FOR GRANDIO SUMMIT FLAT MOUNT BASE KITS

WOOD ANCHORING KIT PARTS LIST FOR ALL SIZES

GRAPHIC	PART NAME	12X8	12X12	12X16	12X20	12X24	12X28	12X32
	M6x50 DECK SCREW	44	52	60	68	76	84	92
	5mm Insert Bit	1	1	1	1	1	1	1
	SEALING TAPE	50'	50'	100'	100'	100'	100'	100'

ADDITIONAL ITEMS NEEDED:

- DRILL
- BUBBLE LEVEL
- TAPE MEASURE
- MARKER OR SOFT PENCIL
- SAFETY GLASSES OR GOGGLES

© 2018 Grandio Greenhouses, Backyard Living Source Inc. All rights reserved
2018 Manual Edition Summit Wood Anchoring Kit

GRANDIO WOOD ANCHORING KIT PREPARATION

Before you begin, take time to complete this check list. ✓

There are a few things every foundation should provide:

- 1. Your foundation must be anchored to the ground (Wind gusts can move or turn over a greenhouse because of its low weight to surface area ratio). Before you start any foundation, you should know the greenhouse's outside base dimensions. The dimensions are listed in the Grandio Manual for each size base kit. Be sure to prepare and level your surface prior to installation.
- 2. There must be a way for water to drain out of the greenhouse (If water doesn't drain, it will collect on the floor and become stagnant promoting algae, disease, insect growth, and may create a walking hazard in freezing temperatures).
- 3. Measures should be taken to prevent weeds and grass from growing in the greenhouse floor (Greenhouses will provide optimum conditions for weeds to grow along with other the plants you have. Weeds can harbor harmful insects and diseases and should be kept out of the greenhouse).
- 4. Insure that your wooden surface is anchored properly, the wood anchors provided are only as secure as the foundation they attach to.
- 5. Assemble your Grandio Base Kit according to the instructions in your **Grandio Summit Greenhouse Manual 1**.
- 6. Carefully apply the foam tape sticky side to the center of the bottom side of your **Summit Flat Mount Base Kit**. Cut the tape to leave gaps open for the anchoring screws. This tape will create a seal for the base kit to the wood surface helping to block drafts.
- 7. Lay your base kit into place, align the base with the wood surface, then measure the base kit from corner to corner for square, use a bubble level to check for any allowances needed, you may purchase washers to shim if needed. Once you have aligned and squared your base, mark the surface to be sure you secure the Flat Mount Base Kit into place accurately.

Follow the steps for installing your anchor screws in this supplement manual.

GRANDIO SUMMIT WOOD ANCHORING KIT INSTALLATION

STOP
You must confirm that the Flat Mount Base Kit is assembled correctly. See the graphics below.

Walk around your base kit and confirm that your notches on the flat mount base have approximately 23" between each other. No notches should be right next to each other. If your base is not correct, refer to Summit Manual 1 and research your exact greenhouse size to see the correct orientation.

IF YOU INSTALL AN INCORRECTLY ASSEMBLED FLAT MOUNT BASE KIT YOU WILL NOT BE ABLE TO PROCEED IN LATER SECTIONS!!

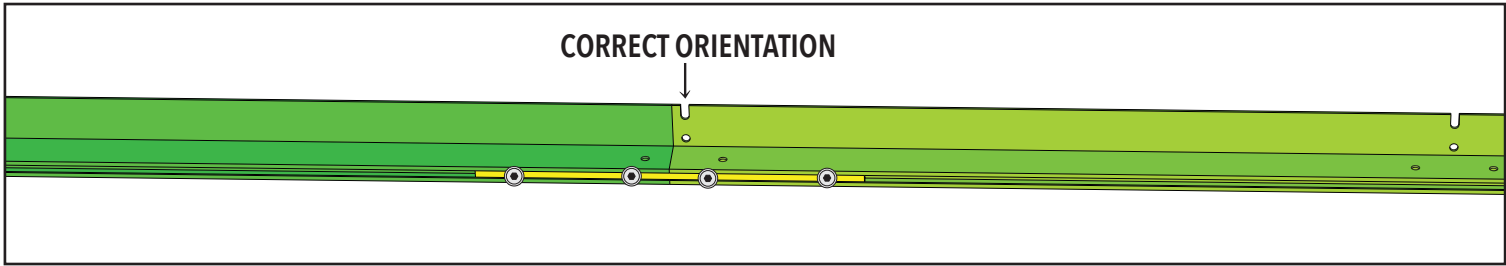
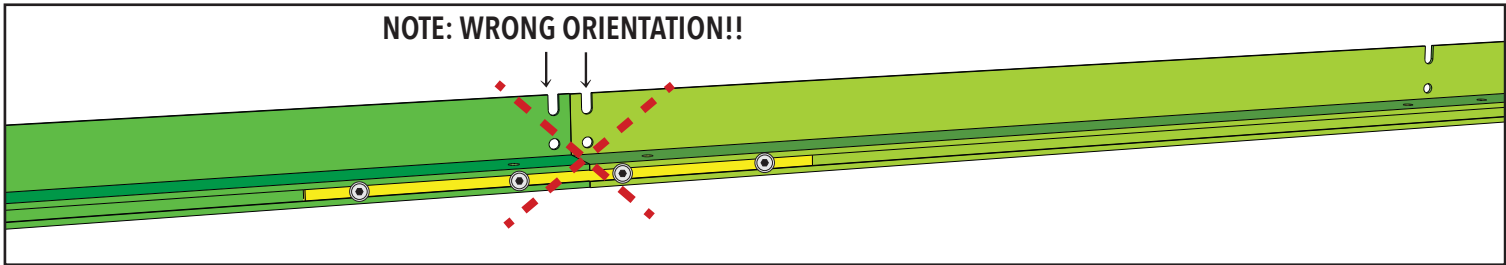
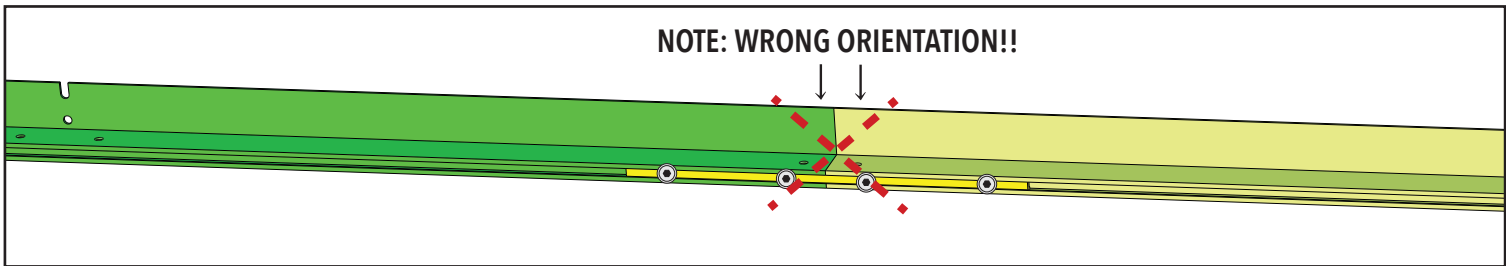

GRANDIO WOOD ANCHORING KIT INSTALLATION

NOTE: You will remove the front and back sections of the base kit to assemble the front and back walls of the greenhouse in **GREENHOUSE ASSEMBLY MANUAL 2**.

1. Align your Flat Mount Base Kit into place and square up to your surface. You will only attach the sides using all screw holes on the side pieces.

Do not anchor the C14 and C15 Caps.

Do not anchor the front and back sections as they will be removed once the sides are squared and secured as the Flat Mount Base front and back pieces are needed to assemble the front and back walls.

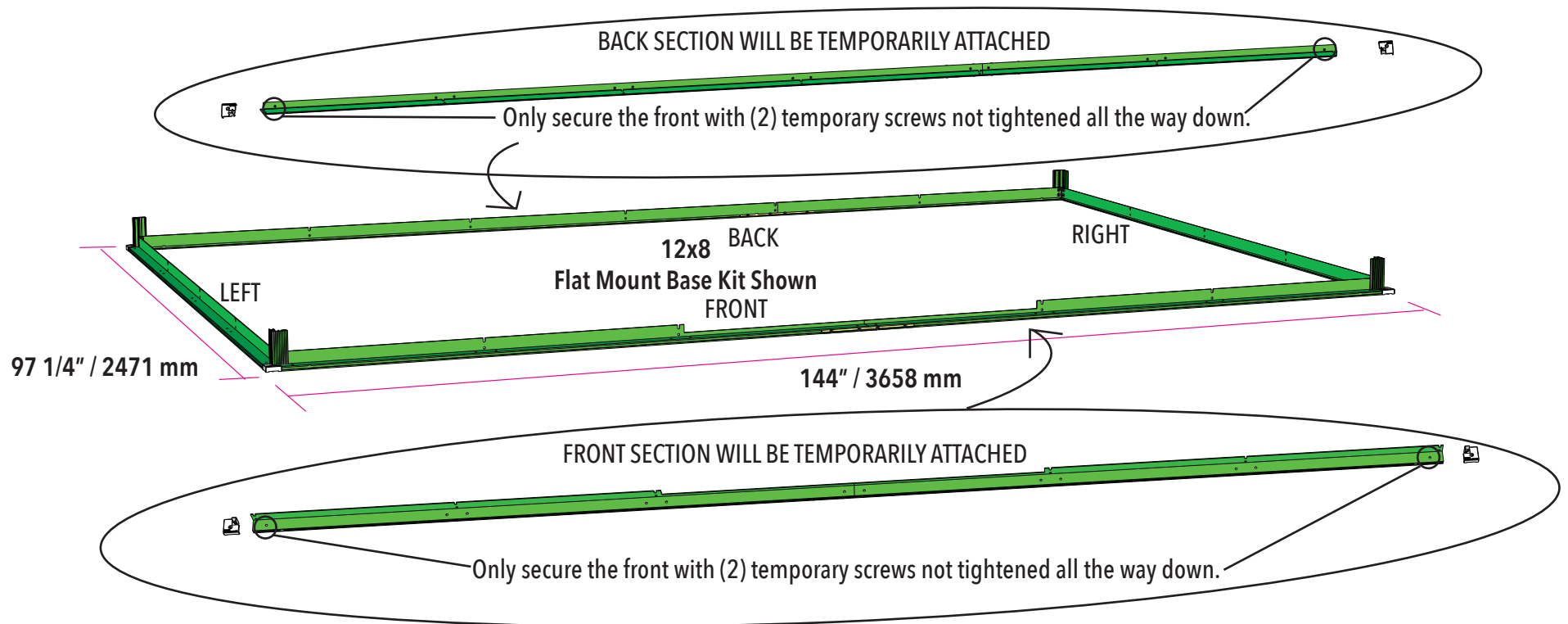

GRANDIO WOOD ANCHORING KIT INSTALLATION

CAUTION: Wear protective eye wear when drilling.

2. Use the provided **M5X50 Deck Screw Fasteners** and **5MM Bit** to secure the sides of the flat mount base kit onto your wooden surface. SEE DIAGRAMS **A** and **B**.

3. You will leave the secured sides in place. Remove the **TEMPORARY SCREWS** and set aside the **FRONT, BACK** and **C14** and **C15 CAPS**. Keep the provided anchoring screws in a safe place for the installation of the **Front** and **Back Walls** later.

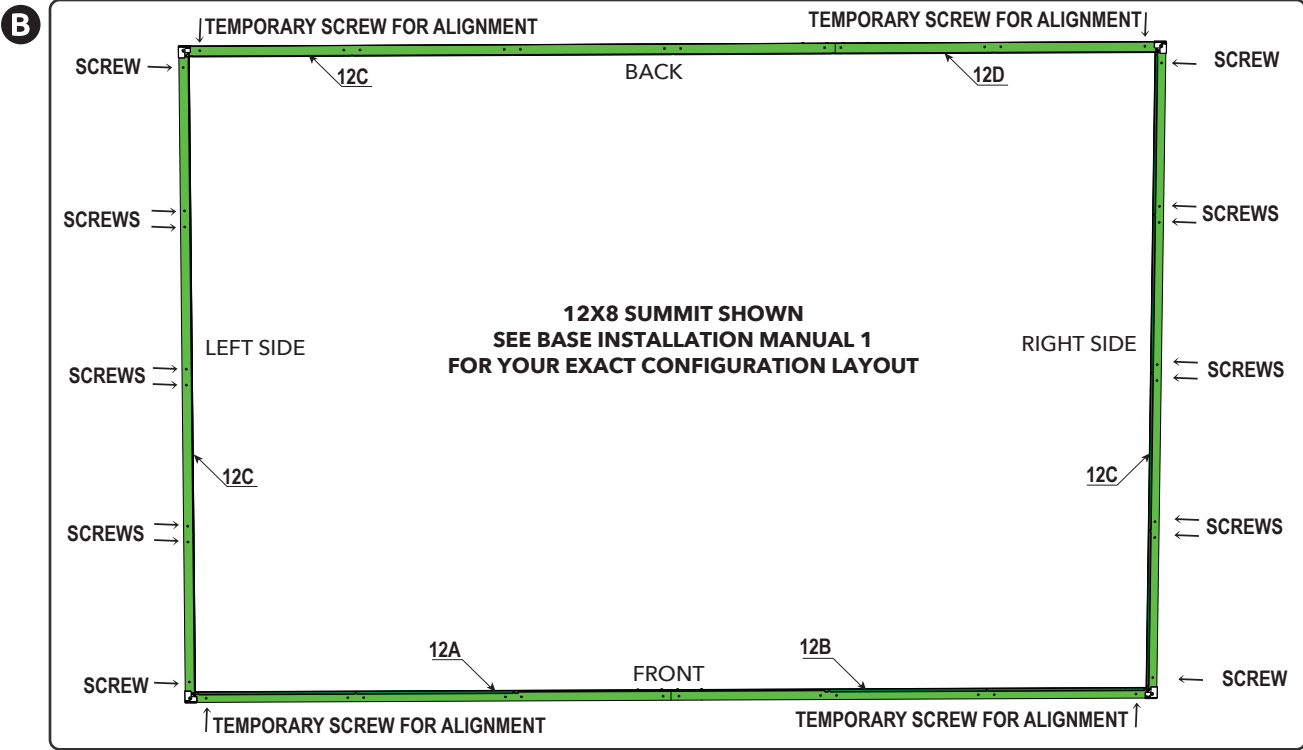
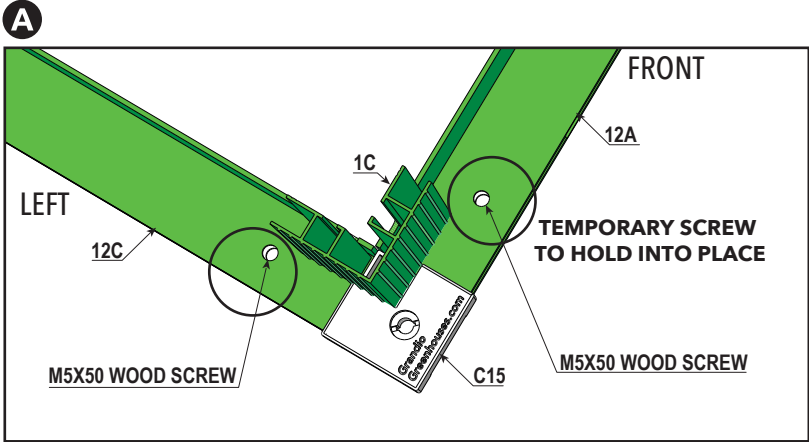



GRANDIO[®]
GREENHOUSES

Grandio Summit Flat Mount Wood Anchor Kit

**INSTALLATION MANUAL
KEEP IN A SAFE PLACE FOR REFERENCE**

CONTACT US IF YOU NEED HELP
OR
HAVE MISSING OR DAMAGED PARTS

GRANDIOGREENHOUSES.COM

**BACKYARD LIVING SOURCE, INC.
9543 W. EMERALD ST., SUITE 101
BOISE, ID 83704
1-866-448-8231**